

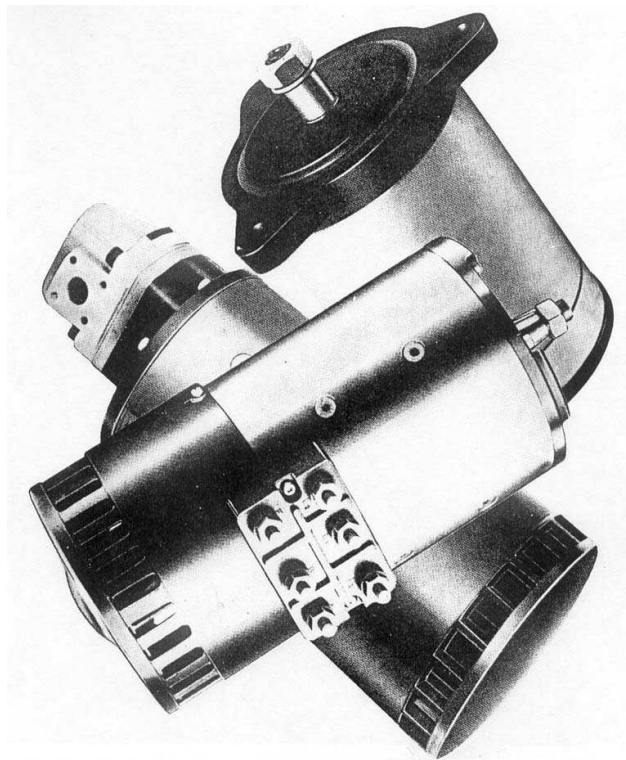

Direct Current Electric motors since 1954
Traction motors, lift electropumps and steering pumps
1200 different models from 200W to 50kW



Via Lenin 37 – 41012 Carpi (MO) – Italy

Tel. ++39-059690055 – fax ++39-059641469

C.FISC.-P.IVA 00170670368

E-MAIL: amre@amre.it

IN-NET: www.amre.it

MAIN APPLICATIONS OF OUR MOTORS

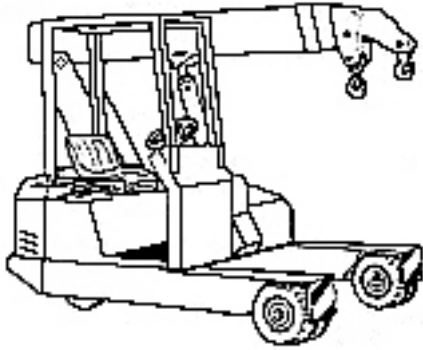

ELECTRIC CRANES



AIRPORT VEHICLES

FORKLIFTS

*Traction
lifting &
steering*

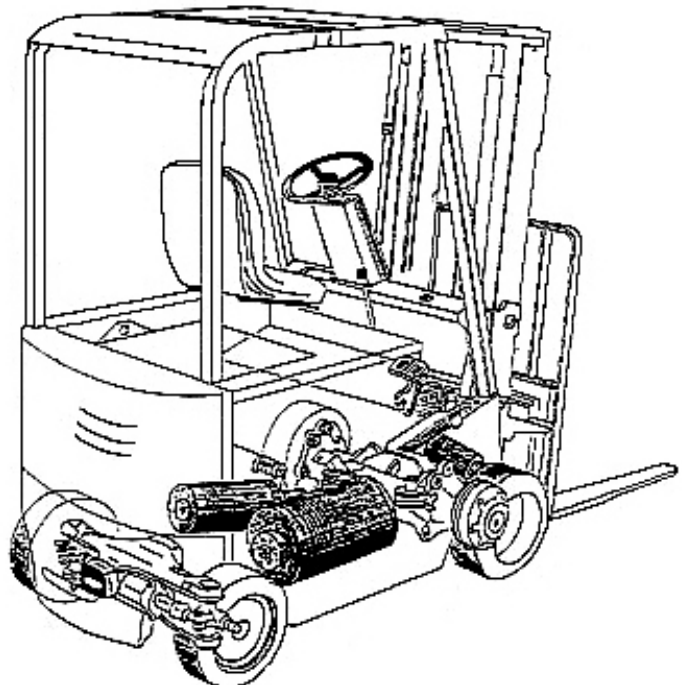

*AMUSEMENT PARK RIDES
AND VEHICLES, GOLF-CAR*

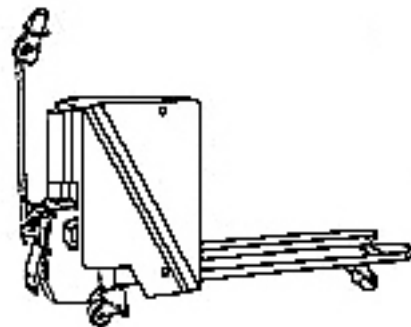

DRIVE WHEELS

BRUSHING MACHINE

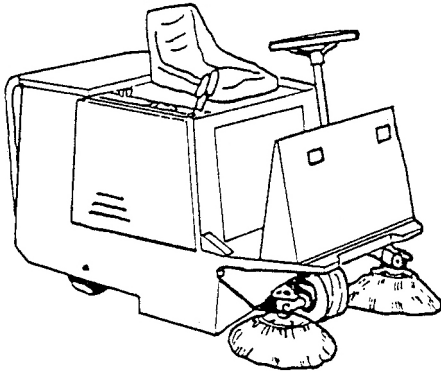

ELECTRIC CARS

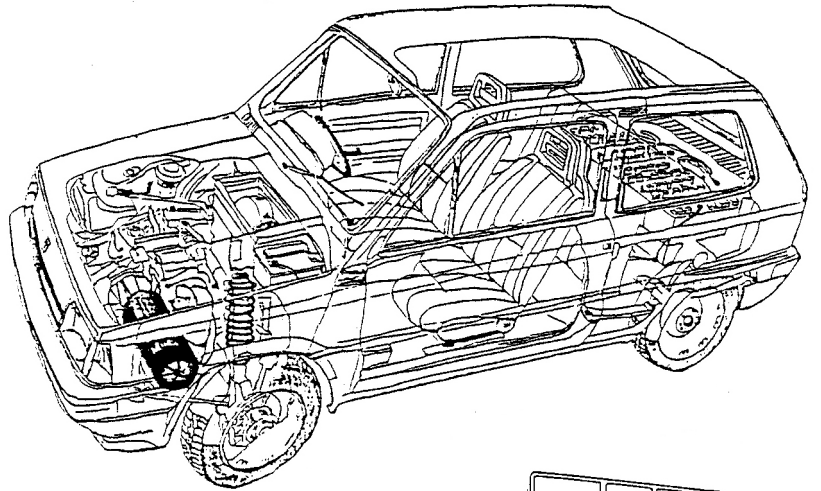

WINCHES

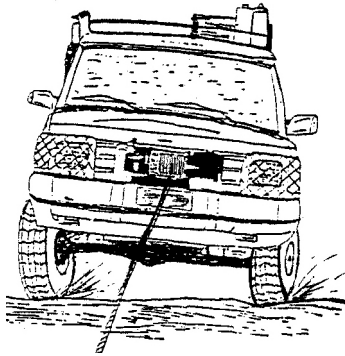

USE IN MARINE ENVIRONMENTS

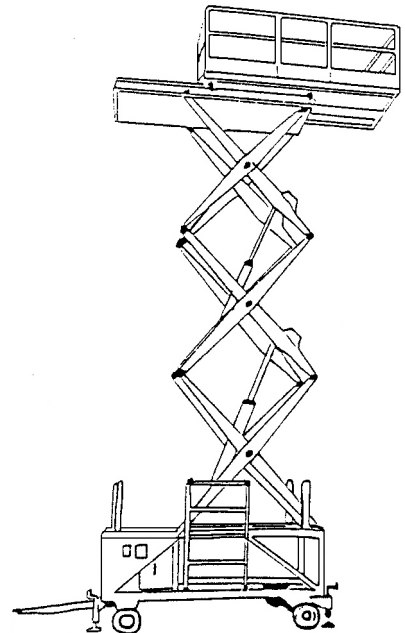
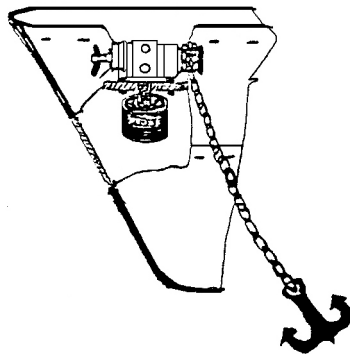

AIR PLATFORMS, TELESCOPIC ARMS

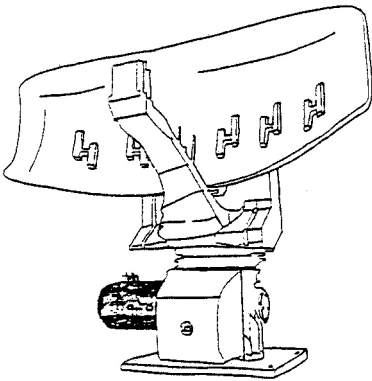

MILITARY STANDARDS

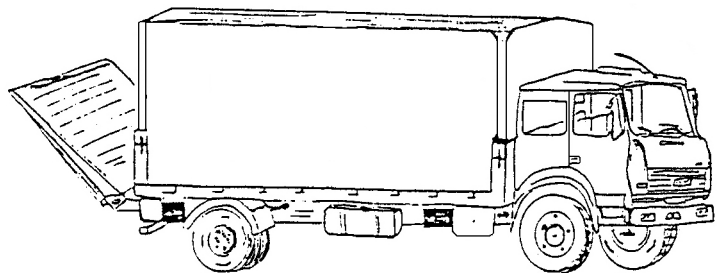

TAIL LIFTS



Via Lenin 37 41012 Carpi (Modena)

www.amre.it

tel. 059-690055 - fax. 059-641469

e-mail amre@amre.it

DC ELECTRIC MOTOR DIAMETER 112



TRACTION MOTOR Ø112

PART NUMBER	LENGHT(mm)	POWER (WATT)	RPM	VOLT	DUTY SERVICE (minutes)	DRIVE END SHAFT
10424	175	700	2800	12	6 min	Cil. Ø19
10425	175	700	2800	24	12 min	Cil. Ø19
10431	175	800	2100	48	5 min	Cil. Ø14
11007	168	1000	2900	24	9 min	Cil. Ø17
11103	195	1000	2000	12	3 min	Cil.Ø14

ELECTROPUMP Ø112

PART NUMBER	LENGHT(mm)	POWER (WATT)	RPM	VOLT	DUTY SERVICE (minutes)	DRIVE END SHAFT
<u>2212</u>	209	2000	2000	24	4 min	Key Shaft (Bosch) 8x18
<u>2213</u>	204	2000	1800	48	4 min	Key Shaft (Bosch) 8x18
<u>2155</u>	209	1500	2000	12	3 min	Key Shaft (Bosch) 8x18

STEERING PUMP Ø112

PART NUMBER	LENGHT(mm)	POWER (WATT)	RPM	VOLT	DUTY SERVICE (minutes)	DRIVE END SHAFT
<u>2013</u>	204	500	2250	24	20 min	Key Shaft (Bosch) 8x18
<u>2015</u>	209	500	2580	36	15 min	Key Shaft (Bosch) 8x18

**Amre is able to design and develop new motor models
on specific customer requirements**

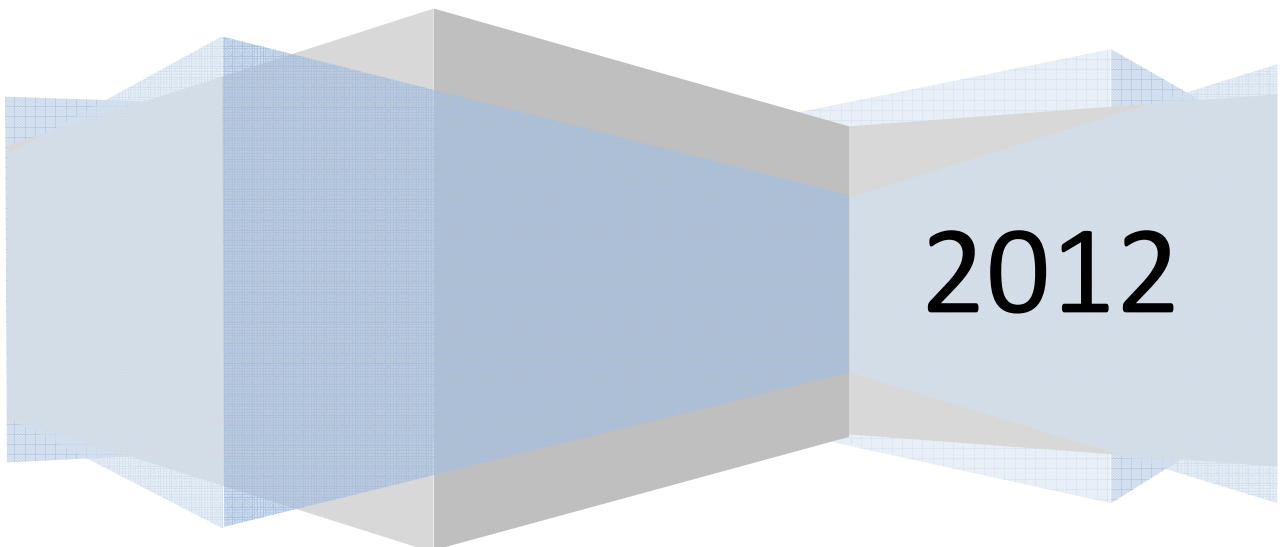



Via Lenin 37 41012 Carpi (Modena)

www.amre.it

tel. 059-690055 - fax. 059-641469

e-mail amre@amre.it

DC ELECTRIC MOTOR DIAMETER 125



TRACTION MOTOR Ø125

PART NUMBER	LENGHT(mm)	POWER (WATT)	RPM	VOLT	DUTY SERVICE (minutes)	DRIVE END SHAFT
10028	224	500	1670	24	60 min	Con.Ø20 1:5
10033	224	500	1400	24	75 min	Con.Ø20 1:5
10395	224	700	2000	24	40 min	Con.Ø20 1:5
11790	242	1500	1600	24	10 min	Con.Ø20 1:5

ELECTROPUMP Ø125

PART NUMBER	LENGHT(mm)	POWER (WATT)	RPM	VOLT	DUTY SERVICE (minutes)	DRIVE END SHAFT
<u>2020</u>	258	700	2250	36	60 min	Key Shaft (Bosch) 8x18
<u>2142</u>	224	1000	2200	80	60 min	Con.Ø20 1:5

STEERING PUMP Ø125

PART NUMBER	LENGHT(mm)	POWER (WATT)	RPM	VOLT	DUTY SERVICE (minutes)	DRIVE END SHAFT
<u>2021</u>	258	500	1670	24	70 min	Key Shaft (Bosch) 8x18
<u>2024</u>	258	800	1800	48	60 min	Key Shaft (Bosch) 8x18
<u>2127</u>	258	1000	2000	72-80	60 min	Key Shaft (Bosch) 8x18

**Amre is able to design and develop new motor models
on specific customer requirements**

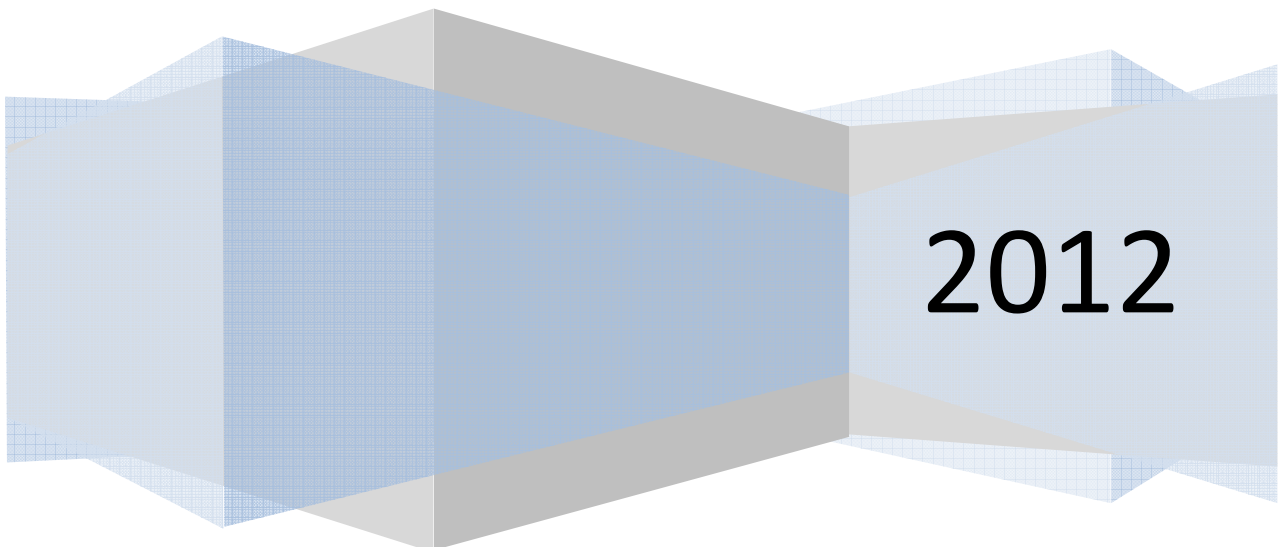



Via Lenin 37 41012 Carpi (Modena)

www.amre.it

tel. 059-690055 - fax. 059-641469

e-mail amre@amre.it

DC ELECTRIC MOTOR DIAMETER 150



TRACTION MOTOR Ø150

PART NUMBER	LENGHT(mm)	POWER (WATT)	RPM	VOLT	DUTY SERVICE (minutes)	DRIVE END SHAFT
11781	292	1500	2000	48	S1	Cil. Ø19
12000	254	2000	1900	24	17,5 min	Con.Ø20 1:5
12087	299	2000	4000	24	60 min	Con.Ø20 1:5
12781	292	2500	2000	36	60 min	Cil. Ø25

ELECTROPUMP Ø150

PART NUMBER	LENGHT(mm)	POWER (WATT)	RPM	VOLT	DUTY SERVICE (minutes)	DRIVE END SHAFT
<u>2120A</u>	312	1200	1500	80	60 min	Key Shaft (Bosch) 8x18
<u>2300</u>	339	3000	1490	24	9 min	Key Shaft (Bosch) 8x18
<u>2400</u>	339	4000	1300	24	5,2 min	Key Shaft (Bosch) 8x18
<u>2457</u>	339	4500	3200	48	43 min	Key Shaft (Bosch) 8x18

STEERING PUMP Ø150

PART NUMBER	LENGHT(mm)	POWER (WATT)	RPM	VOLT	DUTY SERVICE (minutes)	DRIVE END SHAFT
<u>2100</u>	284	1000	1480	24	60 min	Key Shaft (Bosch) 8x18
<u>2104</u>	284	1000	1160	48	60 min	Key Shaft (Bosch) 8x18
<u>2108</u>	284	1000	1500	80	60 min	Key Shaft (Bosch) 8x18

Amre is able to design and develop new motor models

on specific customer requirements

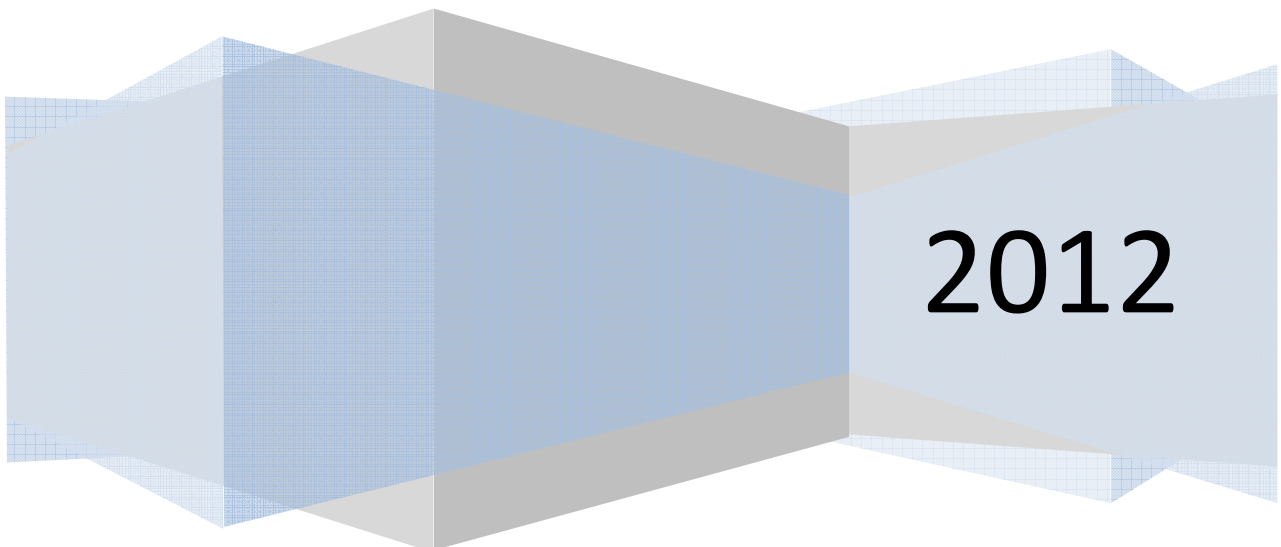



Via Lenin 37 41012 Carpi (Modena)

www.amre.it

tel. 059-690055 - fax. 059-641469

e-mail amre@amre.it

DC ELECTRIC MOTOR DIAMETER 177

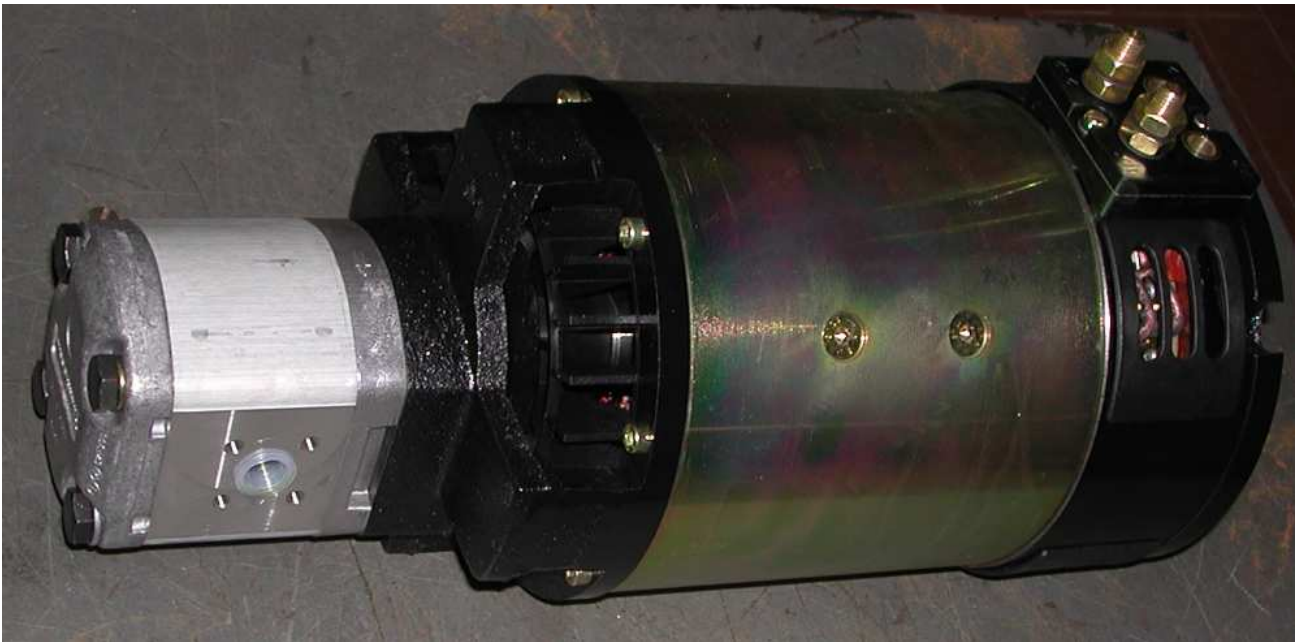

TRACTION MOTOR Ø177

PART NUMBER	LENGHT(mm)	POWER (WATT)	RPM	VOLT	DUTY SERVICE (minutes)	DRIVE END SHAFT
13766	387	3500	1100	48	20	Con.Ø25 1:5
14059	487	5000	1365	48	60	Con.Ø25 1:5
14133	387	5000	1950	36	60	Cil. Ø25
15056	487	8000	2400	80	60	Con.Ø25 1:5

ELECTROPUMP Ø177

PART NUMBER	LENGHT(mm)	POWER (WATT)	RPM	VOLT	DUTY SERVICE (minutes)	DRIVE END SHAFT
2703	403	8000	1720	80	7	Key Shaft (Bosch) 8x18
2512	391	5000	2500	48	60	Key Shaft (Bosch) 8x18
2713	403	6000	1500	36	10	Key Shaft (Bosch) 8x18
2721	503	8000	1150	48	10	Key Shaft (Bosch) 8x18

STEERING PUMP Ø177

PART NUMBER	LENGHT(mm)	POWER (WATT)	RPM	VOLT	DUTY SERVICE (minutes)	DRIVE END SHAFT
2207	391	2000	1160	48	S1	Key Shaft (Bosch) 8x18
2221A	346,5	2000	1600	80	60	Key Shaft (Bosch) 8x18
2226A	346,5	2000	1600	80	60	Key Shaft (Bosch) 8x18
2228	346,5	2000	2000	80	60	Key Shaft (Bosch) 8x18

Amre is able to design and develop new motor models

on specific customer requirements

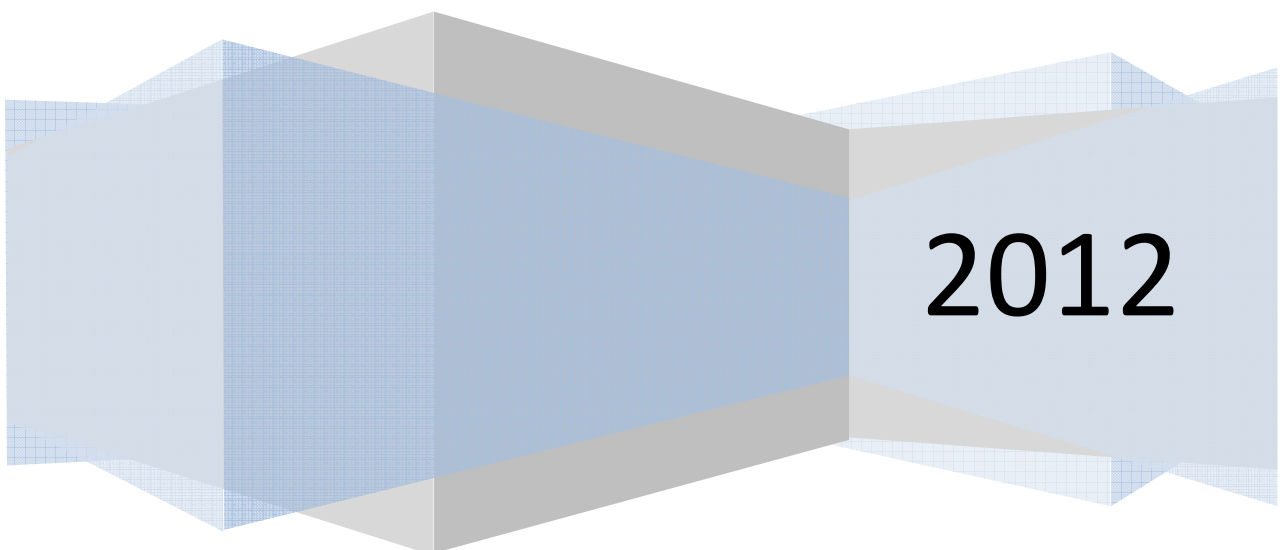



Via Lenin 37 41012 Carpi (Modena)

www.amre.it

tel. 059-690055 - fax. 059-641469

e-mail amre@amre.it

DC ELECTRIC MOTOR DIAMETER 217



TRACTION MOTOR Ø217

PART NUMBER	LENGHT(mm)	POWER (WATT)	RPM	VOLT	DUTY SERVICE (minutes)	DRIVE END SHAFT
14129	328	5000	1700	48	S1	Con.Ø24 1:5
15008	328	6000	1950	48	60 min	Con.Ø24 1:5
15017	340	6000	2800	80	40 min	Splined Ø 30x27
15015	410	6800	1650	48	60 min	Cil. Ø28

ELECTROPUMP Ø217

PART NUMBER	LENGHT(mm)	POWER (WATT)	RPM	VOLT	DUTY SERVICE (minutes)	DRIVE END SHAFT
2762	354	9000	2400	48	10	Key Shaft (Bosch) 10x25
2838Y	425	12000	2000	80	10	Key Shaft (Bosch) 10x25
2854	354	10000	2400	80	10	Key Shaft (Bosch) 10x25
2846Y	354	12000	2300	80	10	Key Shaft (Bosch) 10x25
2925	485	17000	1800	80	12	Key Shaft (Bosch) 10x25

**Amre is able to design and develop new motor models
on specific customer requirements**

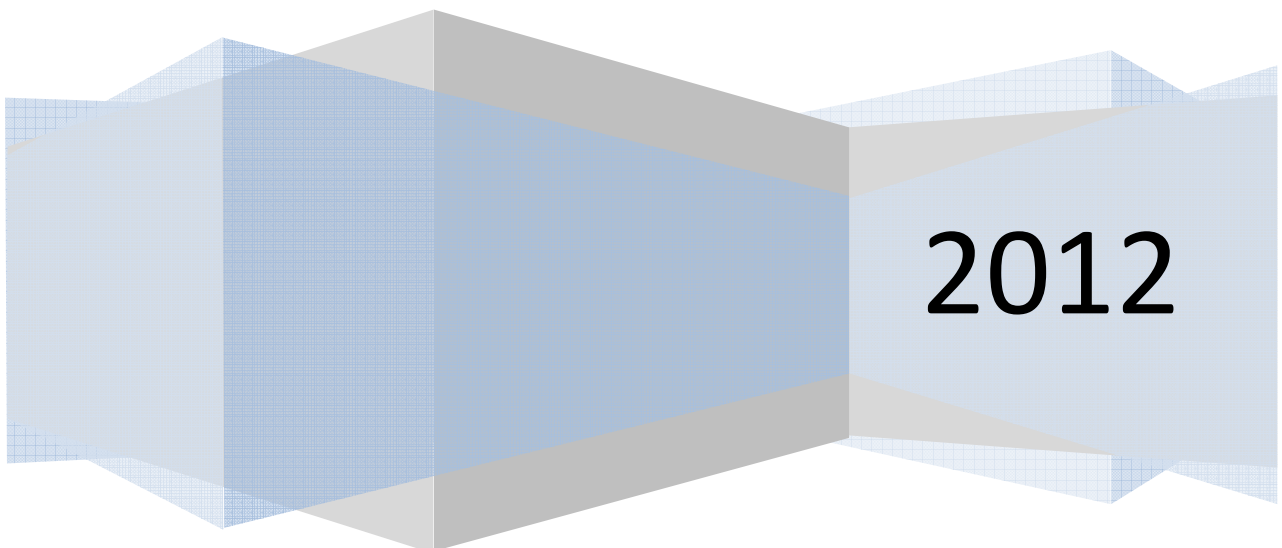



Via Lenin 37 41012 Carpi (Modena)

www.amre.it

tel. 059-690055 - fax. 059-641469

e-mail amre@amre.it

DC ELECTRIC MOTOR DIAMETER 244



TRACTION MOTOR Ø244

PART NUMBER	LENGHT(mm)	POWER (WATT)	RPM	VOLT	DUTY SERVICE (minutes)	DRIVE END SHAFT
13812	337	3600	1700	80	S1	Con.Ø28 1:10
14132	337	6000	1800	48	50 min	Cil. Ø28
15046	356	7500	1500	48	35 min	Splined female
16062	447	12000	1060	80	30 min	Splined female

ELECTROPUMP Ø244

PART NUMBER	LENGHT(mm)	POWER (WATT)	RPM	VOLT	DUTY SERVICE (minutes)	DRIVE END SHAFT
2814	444	10000	1000	48	15	Key Shaft (Bosch) 10x20
2805	448	10000	1700	80	38	Key Shaft (Bosch) 16x35
2828	448	12000	1600	80	21	Key Shaft (Bosch) 16x35
2900	531,5	14000	1160	72	17	Key Shaft (Bosch) 16x48

**Amre is able to design and develop new motor models
on specific customer requirements**

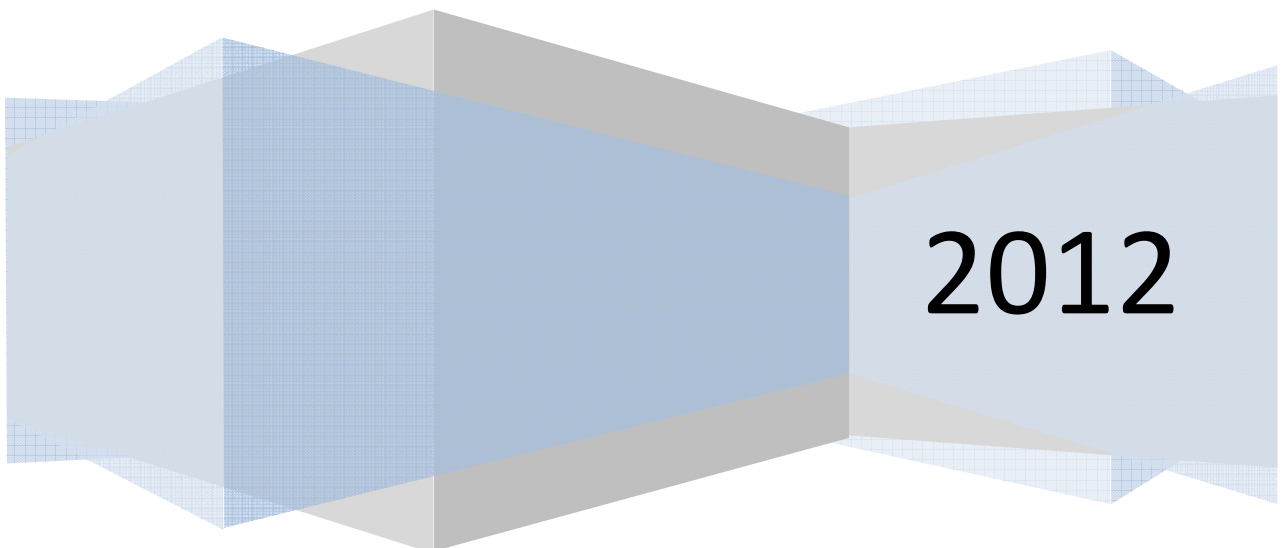



Via Lenin 37 41012 Carpi (Modena)

www.amre.it

tel. 059-690055 - fax. 059-641469

e-mail amre@amre.it

DC ELECTRIC MOTOR DIAMETER 253



TRACTION MOTOR Ø253

PART NUMBER	LENGHT(mm)	POWER (WATT)	RPM	VOLT	DUTY SERVICE (minutes)	DRIVE END SHAFT
15032	400	6000	1750	72	60	Splined 38x34
15066	421	8000	1170	48	33	Splined 30x27
15099	440	9000	1800	80	60	Splined female
15514	421	10000	1900	80	60	Splined 30x27

ELECTROPUMP Ø253

PART NUMBER	LENGHT(mm)	POWER (WATT)	RPM	VOLT	DUTY SERVICE (minutes)	DRIVE END SHAFT
2920	414,5	14000	1850	72	18	Key Shaft (Bosch) 10x25
2903	448	15500	1370	80	7	Key Shaft (Bosch) 16x35
2917	448	16800	1950	80	16	Key Shaft (Bosch) 16x35

**Amre is able to design and develop new motor models
on specific customer requirements**

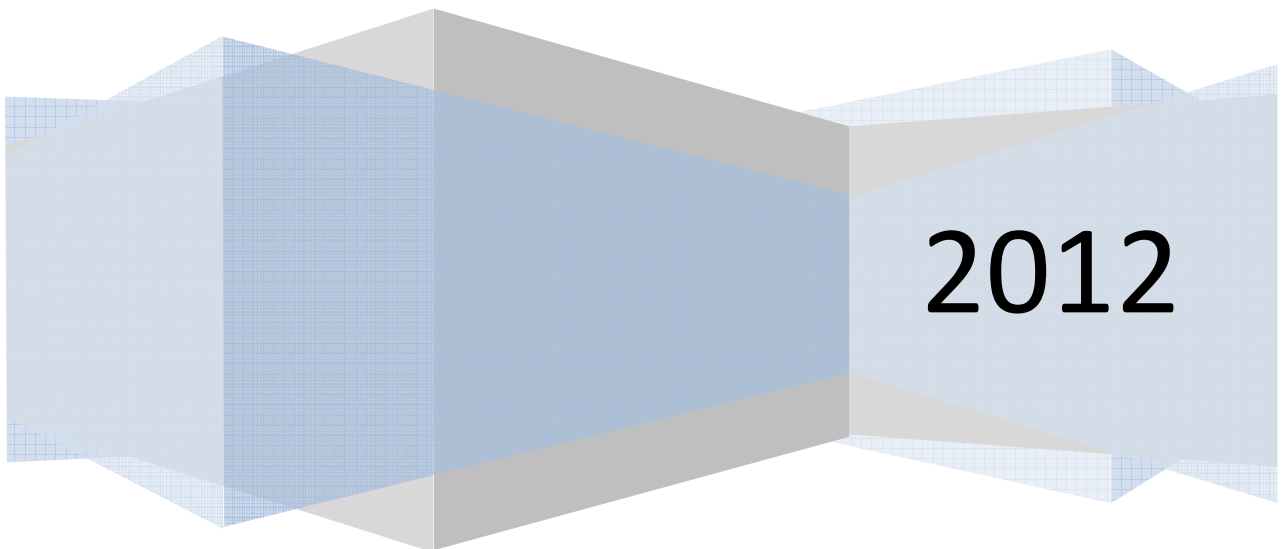



Via Lenin 37 41012 Carpi (Modena)

www.amre.it

tel. 059-690055 - fax. 059-641469

e-mail amre@amre.it

DC ELECTRIC MOTOR DIAMETER 295

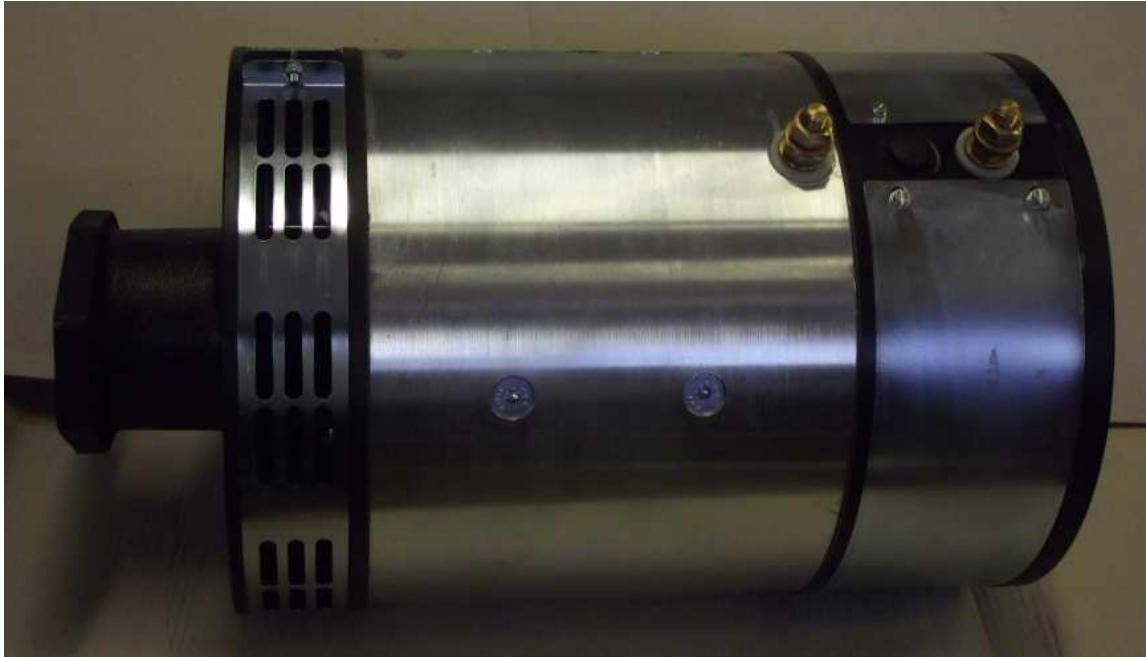

TRACTION MOTOR Ø295

PART NUMBER	LENGHT(mm)	POWER (WATT)	RPM	VOLT	DUTY SERVICE (minutes)	DRIVE END SHAFT
15090	420	8000	1230	48	60	Splined 30x27
16504	420	15000	1700	80	40	Splined 30x27
16510	541	15000	1300	80	60	Splined 38x32
16541Y	541	18500	1700	80	60	Splined 38x34
16529Y	541	20000	1900	80	43	Splined 32x28

ELECTROPUMP Ø295

PART NUMBER	LENGHT(mm)	POWER (WATT)	RPM	VOLT	DUTY SERVICE (minutes)	DRIVE END SHAFT
2834	422	10000	1800	48	60	Splined 38x34
2934Y	541	18600	2000	80	60	Key Shaft (Bosch) 16x32
2951Y	541	22000	1850	80	30	Key Shaft (Bosch) 16x32
2955Y	543	26000	2200	96	30	Splined 38x34
2957Y	543	28000	1800	96	15	Splined female

**Amre is able to design and develop new motor models
on specific customer requirements**

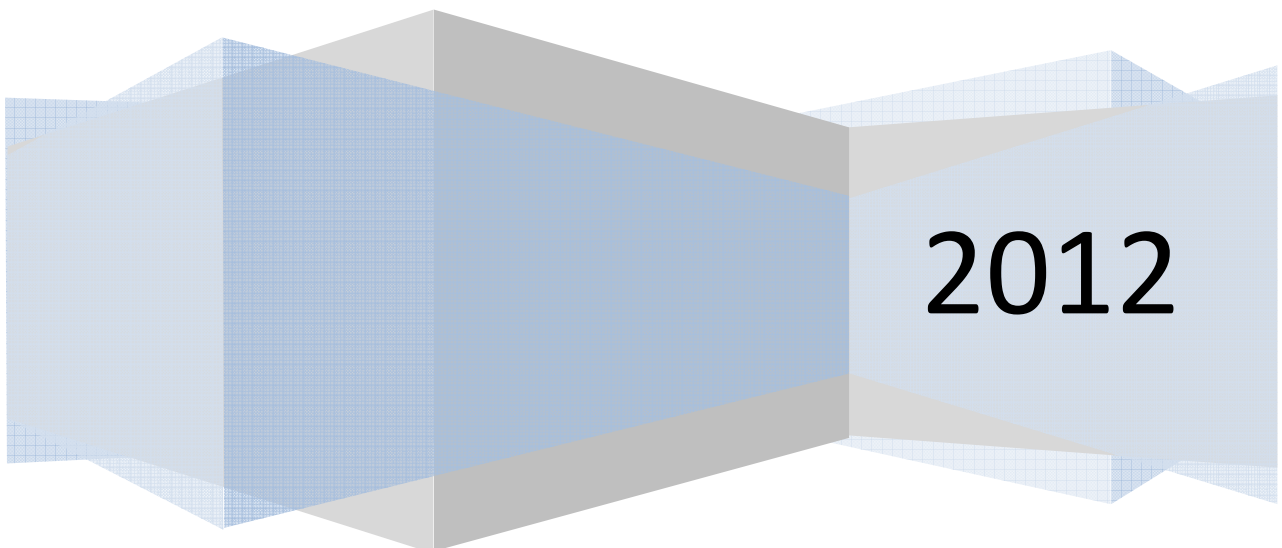



Via Lenin 37 41012 Carpi (Modena)

www.amre.it

tel. 059-690055 - fax. 059-641469

e-mail amre@amre.it

DC ELECTRIC MOTOR DIAMETER 365



TRACTION MOTOR Ø365

PART NUMBER	LENGHT(mm)	POWER (WATT)	RPM	VOLT	DUTY SERVICE (minutes)	DRIVE END SHAFT
16501Y	514	20000	1150	80	60	Splined 38x34
16540Y	514	20000	1500	80	60	Splined 42x38
16542Y	514	22000	1500	80	60	Splined 42x38
16513	615	30000	1380	80	60	Splined 42x38
16531Y	615	36000	1650	96	60	Splined 42x38